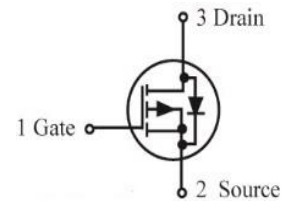

### 1. FEATURES

- We declare that the material of product compliance with RoHS requirements and Halogen Free.
- S- prefix for automotive and other applications requiring unique site and control change requirements; AEC-Q101 qualified and PPAP capable.
- Energy efficient

**SOT23**

### 2. MAXIMUM RATINGS(Ta = 25°C)

Parameter	Symbol	Limits	Unit
Drain-Source Voltage	VDSS	-50	V
Gate-to-Source Voltage – Continuous	VGS	±20	V
Drain Current			mA
– Continuous TA = 25°C	ID	-130	
– Pulsed (tp ≤ 10µs)	IDM	-520	

### 3. THERMAL CHARACTERISTICS

Parameter	Symbol	Limits	Unit
Total Device Dissipation, FR-5 Board (Note 1) @ TA = 25°C Derate above 25°C	PD	225 1.8	mW mW/°C
Thermal Resistance, Junction-to-Ambient(Note 1)	RθJA	556	°C/W
Junction and Storage temperature	TJ, Tstg	-55~+150	°C
Maximum Lead Temperature for Soldering Purposes, for 10 seconds	TL	260	°C

1. FR-5 = 1.0×0.75×0.062 in.

**4. ELECTRICAL CHARACTERISTICS (Ta= 25°C)**
**OFF CHARACTERISTICS**

Characteristic	Symbol	Min.	Typ.	Max.	Unit
Drain–Source Breakdown Voltage (VGS = 0, ID = -250μA)	VBRDSS	-50	-	-	V
Zero Gate Voltage Drain Current (VGS = 0, VDS = -25 V) (VGS = 0, VDS = -50 V) (VGS = 0, VDS = -50 V, TJ=125°C)	IDSS	-	-	-0.1 -15 -60	μA
Gate–Body Leakage Current, Forward (VGS = 20V)	IGSSF	-	-	10	μA
Gate–Body Leakage Current, Reverse (VGS = - 20V)	IGSSR	-	-	-10	μA

**ON CHARACTERISTICS (Note 2)**

Gate Threshold Voltage (VDS = VGS, ID = -250μA)	VGS(th)	-0.8	-	-2	V
Static Drain–Source On–State Resistance (VGS = -5.0 V, ID = -100 mA) (VGS = -10 V, ID = -100 mA)	RDS(on)	-	2 1.8	6 5	Ω
Transfer Admittance (VDS = -25 V, ID = -100 mA, f = 1.0 kHz)	yfs	50	-	-	mS

**DYNAMIC CHARACTERISTICS**

Input Capacitance (VDS = - 15V, VGS=0V, f=1MHz)	Ciss	-	38	-	pF
Output Capacitance (VDS = - 15V, VGS=0V, f=1MHz)	Coss	-	4.8	-	pF
Reverse Transfer Capacitance (VDS = - 15V, VGS=0V, f=1MHz)	Crss	-	2.7	-	pF

**SWITCHING CHARACTERISTICS**

Turn-On Delay Time	(VDS = -15 V, VGS=-10V , RL = 50Ω, RG=25Ω)	td(on)	-	16.7	-	ns
Rise Time		tr	-	8.6	-	
Turn-Off Delay Time		td(off)	-	17.9	-	
Fall Time		tf	-	5.3	-	

**SOURCE–DRAIN DIODE CHARACTERISTICS**

Continuous Current	IS	-	-	-0.13	A
Pulsed Current	ISM	-	-	-0.52	A
Forward Voltage	VSD	-	-2.5	-	V

2.Pulse Test: Pulse Width ≤300 μs, Duty Cycle ≤2.0%.

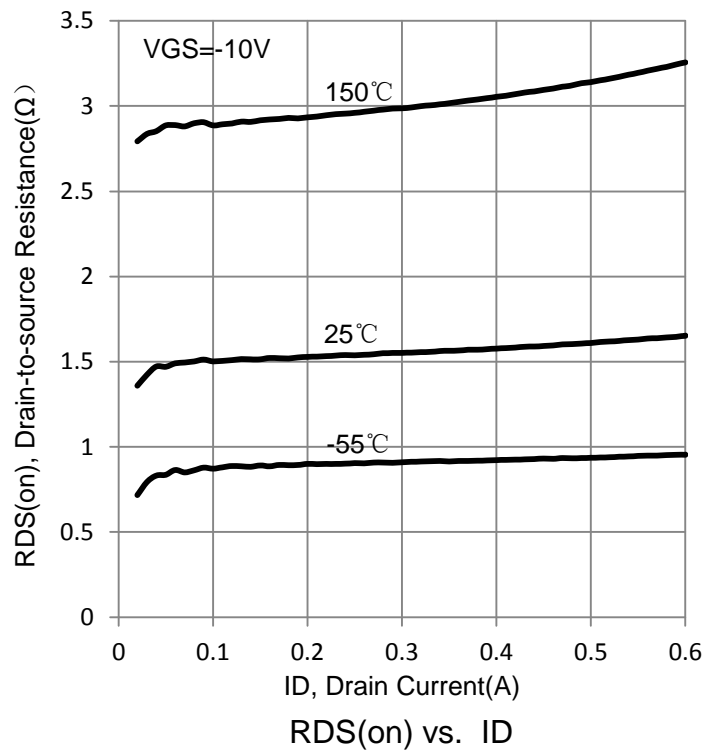
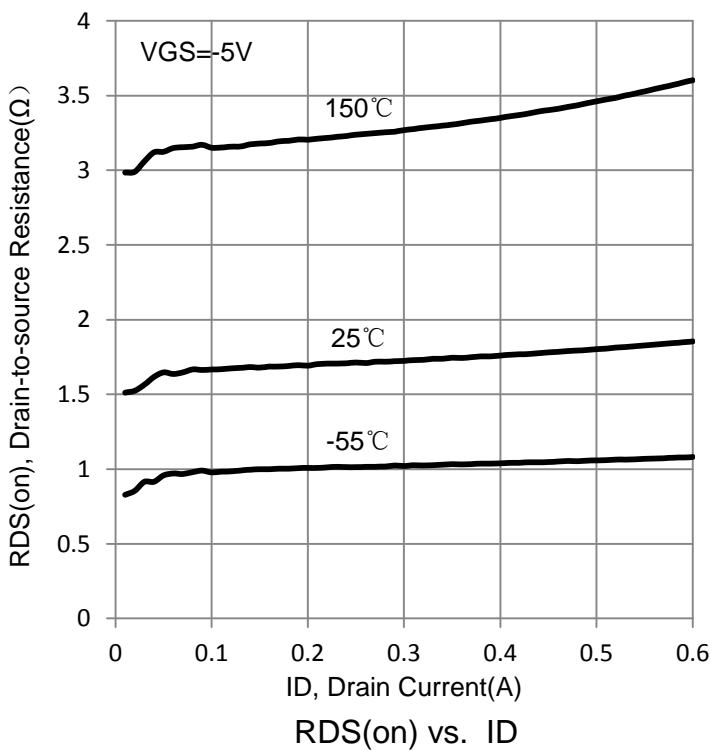
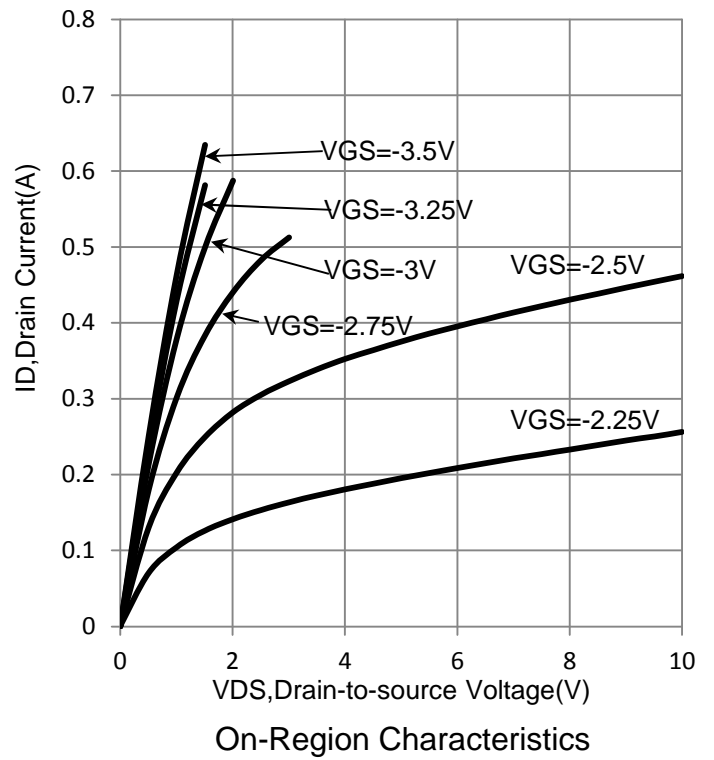
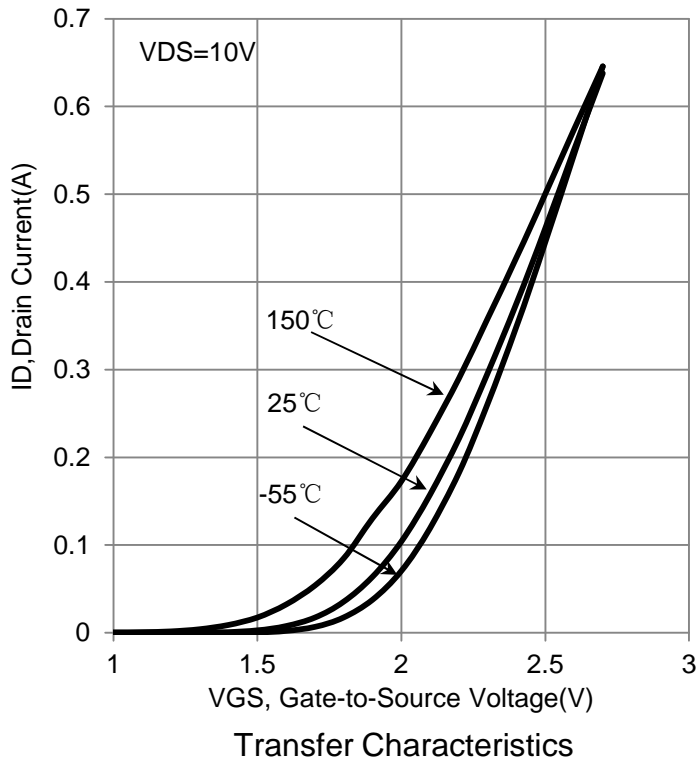
**5. ELECTRICAL CHARACTERISTICS CURVES**

**6. ELECTRICAL CHARACTERISTICS CURVES(Con.)**

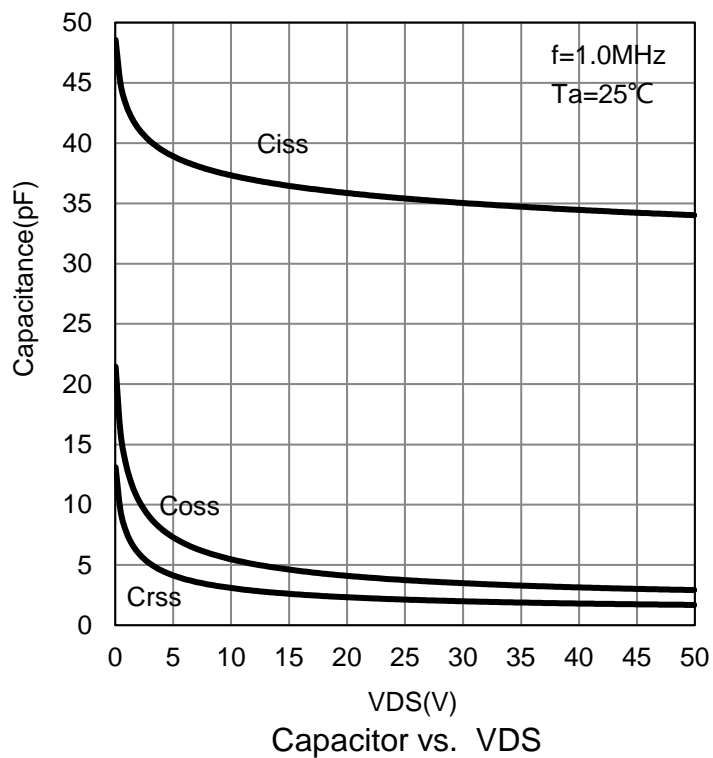
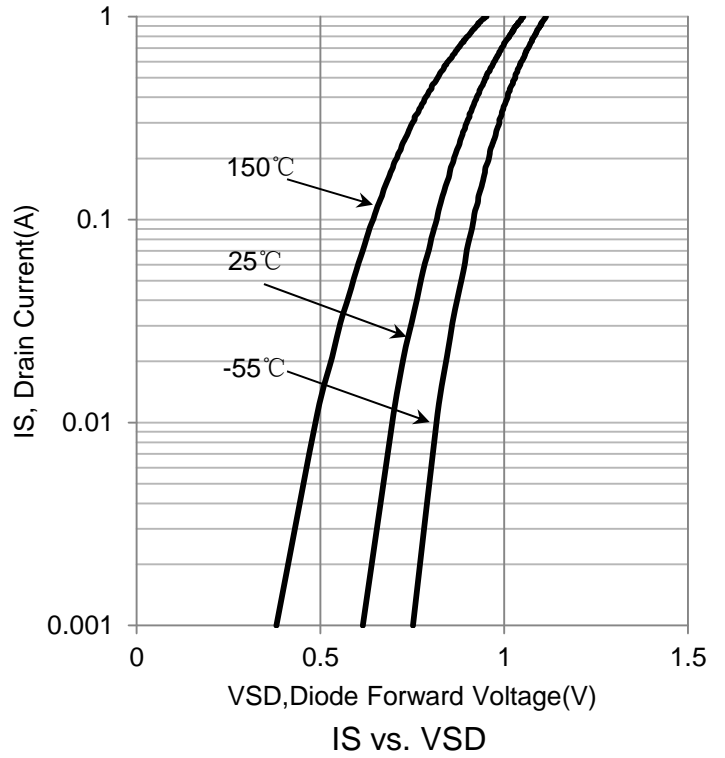
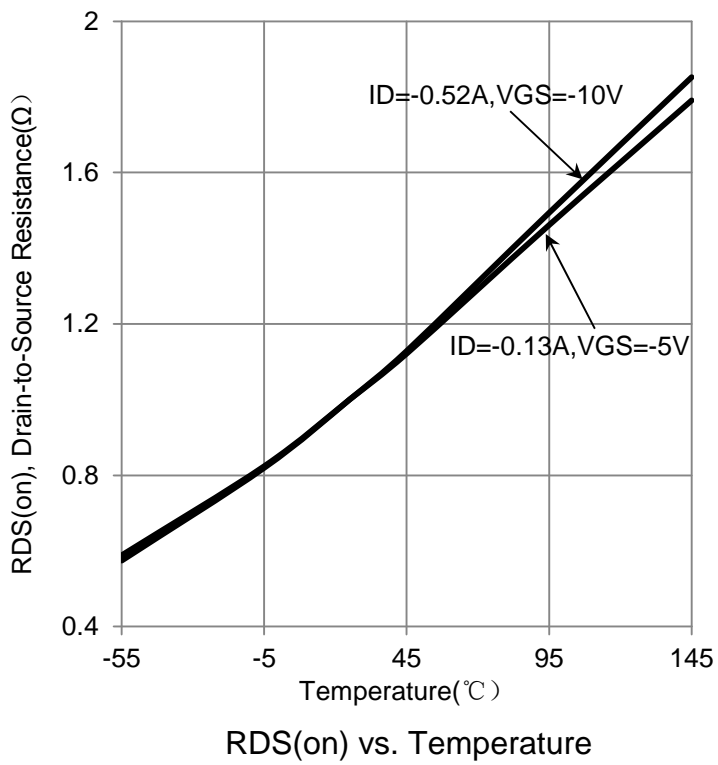

**7.OUTLINE AND DIMENSIONS**

Notes:

1. DIMENSIONING AND TOLERANCING PER ANSI Y14.5M, 1982.
2. CONTROLLING DIMENSION: MILLIMETERS.
3. MAXIMUM LEAD THICKNESS INCLUDES LEAD FINISH. MINIMUM LEAD THICKNESS IS THE MINIMUM THICKNESS OF BASE MATERIAL.
4. DIMENSIONS D AND E DO NOT INCLUDE MOLD FLASH, PROTRUSIONS OR GATE BURRS.

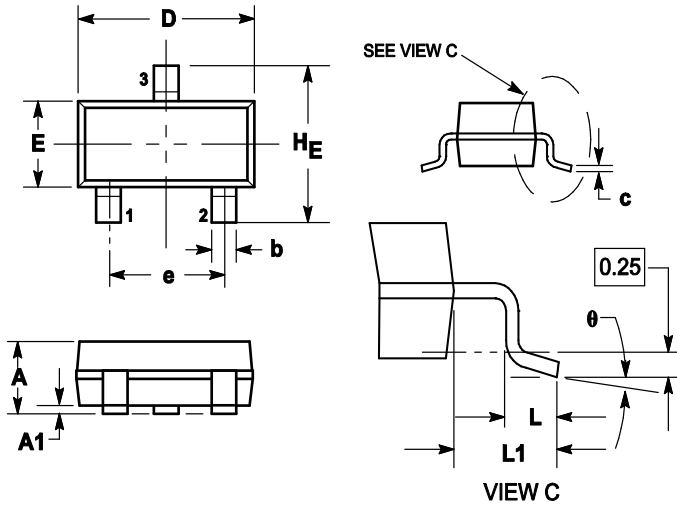

DIM	MILLIMETERS			INCHES		
	MIN	NOM	MAX	MIN	NOM	MAX
A	0.89	1	1.11	0.035	0.04	0.044
A1	0.01	0.06	0.1	0.001	0.002	0.004
b	0.37	0.44	0.5	0.015	0.018	0.02
c	0.09	0.13	0.18	0.003	0.005	0.007
D	2.80	2.9	3.04	0.11	0.114	0.12
E	1.20	1.3	1.4	0.047	0.051	0.055
e	1.78	1.9	2.04	0.07	0.075	0.081
L	0.10	0.2	0.3	0.004	0.008	0.012
L1	0.35	0.54	0.69	0.014	0.021	0.029
HE	2.10	2.4	2.64	0.083	0.094	0.104
$\theta$	0°	---	10°	0°	---	10°

**8.SOLDERING FOOTPRINT**
