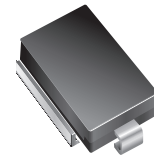

# Surface Mount Automotive Transient Voltage Suppressors

## FEATURES

- Junction passivation optimized design passivated anisotropic rectifier technology.
- $T_J = 175^{\circ}\text{C}$  capability suitable for high reliability and automotive requirement.
- Available in uni-directional polarity only.
- Low leakage current.
- Low forward voltage drop.
- High surge capability.
- Meets ISO16750-2 surge specification (varied by test condition).
- Meets MSL-1, per J-STD-020, LF maximum peak of  $245^{\circ}\text{C}$
- AEC-Q101 qualified.
- Compliant to RoHS directive 2011/65/EU and in accordance to WEEE 2002/96/EC.

**DO-218AB**

Dim	Millimeters		Inches	
	MIN	MAX	MIN	MAX
A	13.2	13.8	0.539	0.543
A1	15	16	0.612	0.630
A2	10	10.5	0.408	0.413
B	10.1	10.3	0.412	0.406
B1	7	7.5	0.286	0.295
B2	3.2	4	0.131	0.157
C	4.8	5.2	0.196	0.205
C1	1.9	2.1	0.078	0.083
D	0.5	0.7	0.020	0.028
E	3.2	4.2	0.131	0.165
F	1.5	3	0.061	0.118
G	-0.04	0.08	-0.002	0.003

## MECHANICAL DATA

**Case:** DO-218AB

Molding compound meets UL 94V-0 flammability rating

Base P/NHE3-RoHS-compliant, AEC-Q101 qualified

**Terminals:** Matte tin plated leads, solderable per J-STD-002

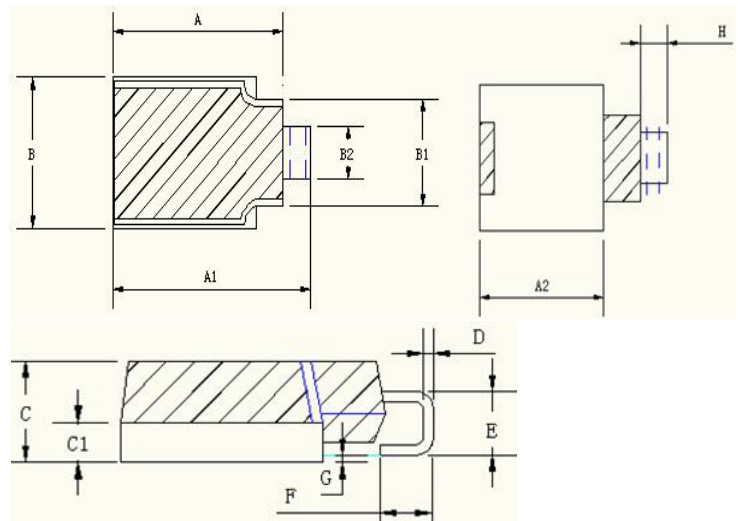

## Maximum Ratings And Thermal Characteristics

Rating at  $25^{\circ}\text{C}$  ambient temperature unless otherwise specified

Parameter	Symbo	Value	Units
Peak Power Dissipation (Note 1.) @ $T_L = 25^{\circ}\text{C}$ , Pulse Width = 1 ms	$P_{PK}$	6600	W
Forward Surge Current (Note 2.) @ $T_A = 25^{\circ}\text{C}$	$I_{FSM}$	100	A
Power Dissipation On Infinite Heatsink, @ $T_A = 50^{\circ}\text{C}$	$P_{M(AV)}$	5.0	W
Thermal Resistance Junction To Ambient Air (Note 3.)	$R_{\theta JA}$	100	$^{\circ}\text{C/W}$
Thermal Resistance Junction To Leads	$R_{\theta JL}$	20	$^{\circ}\text{C/W}$
Storage Temperature Range	$T_{STG}$	-55 to 150	$^{\circ}\text{C}$
Operating Junction Temperature Range	$T_J$	-55 to 150	$^{\circ}\text{C}$

- 1) 10 X 1000 us, non-repetitive
- 2) 1/2 sine wave (or equivalent square wave), PW = 8.3 ms, duty cycle = 4 pulses per minute maximum
- 3) Mounted on minimum recommended pad layout

**Electrical Characteristics** (T<sub>C</sub> = 25°C unless otherwise noted)

Device Type	Breakdown Voltage V <sub>(BR)</sub> (V)		Test Current I <sub>T</sub> (mA)	Stand-off Voltage V <sub>WM</sub> (V)	Maximum Reverse Leakage at V <sub>WM</sub> I <sub>D</sub> (μA)	Maximum Reverse Leakage at V <sub>WM</sub> T <sub>c</sub> = 175°C I <sub>D</sub> (μA)	Max. Peak Pulse Current at 10/1000μs Waveform (A)	Maximum Clamping Voltage at I <sub>PPM</sub> V <sub>C</sub> (V)
	Min.	Max.						
SM8S10A	11.1	12.3	5.0	10	15	250	388	17.0
SM8S11A	12.2	13.5	5.0	11	10	150	363	18.2
SM8S12A	13.3	14.7	5.0	12	10	150	332	19.9
SM8S13A	14.4	15.9	5.0	13	10	150	307	21.5
SM8S14A	15.6	17.2	5.0	14	10	150	284	23.2
SM8S15A	16.7	18.5	5.0	15	10	150	270	24.4
SM8S16A	17.8	19.7	5.0	16	10	150	254	26.0
SM8S17A	18.9	20.9	5.0	17	10	150	239	27.6
SM8S18A	20.0	22.1	5.0	18	10	150	226	29.2
SM8S20A	22.2	24.5	5.0	20	10	150	204	32.4
SM8S22A	24.4	26.9	5.0	22	10	150	186	35.5
SM8S24A	26.7	29.5	5.0	24	10	150	170	38.9
SM8S26A	28.9	31.9	5.0	26	10	150	157	42.1
SM8S28A	31.1	34.4	5.0	28	10	150	145	45.4
SM8S30A	33.3	36.8	5.0	30	10	150	136	48.4
SM8S33A	36.7	40.6	5.0	33	10	150	124	53.3
SM8S36A	40.0	44.2	5.0	36	10	150	114	58.1
SM8S40A	44.4	49.1	5.0	40	10	150	102	64.5
SM8S43A	47.8	52.8	5.0	43	10	150	95.1	69.4

**Note:** For all types maximum V<sub>F</sub> = 1.8V at I<sub>F</sub> = 100A measured on 8.3ms single half sine-wave or equivalent square wave, duty cycle = 4 pulses per minute maximum

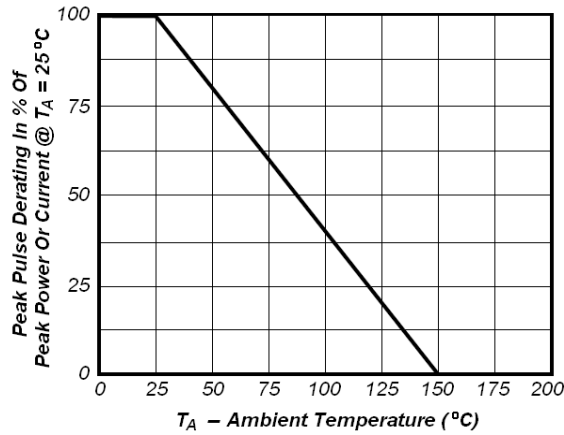
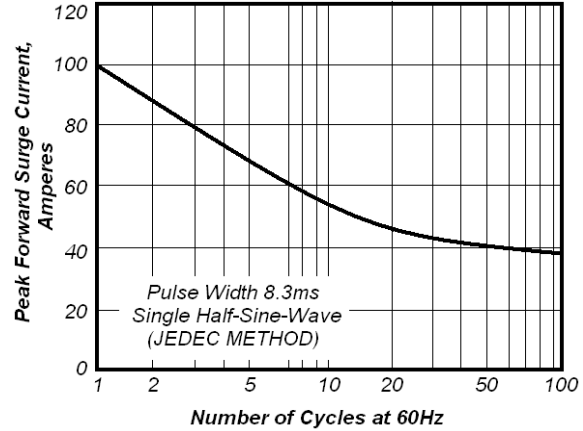
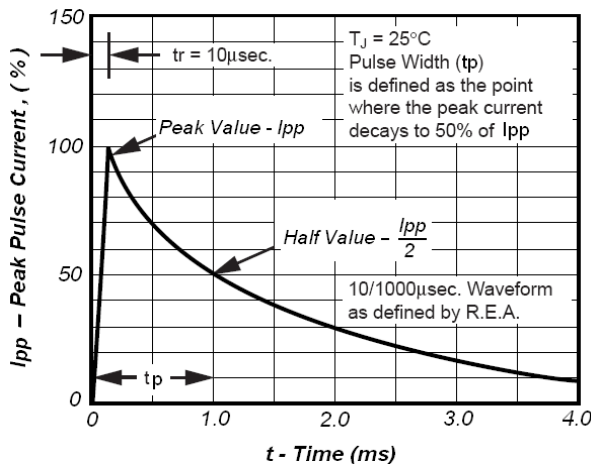
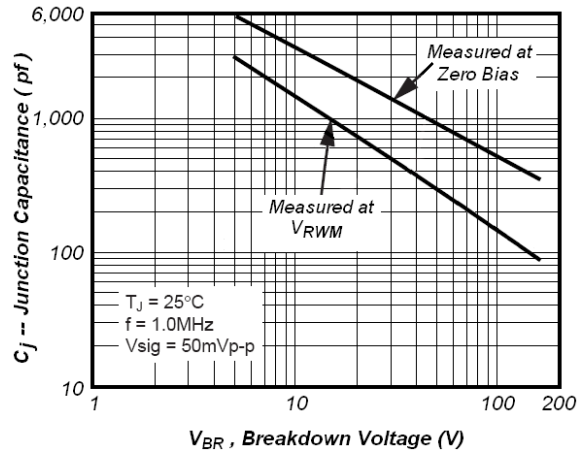
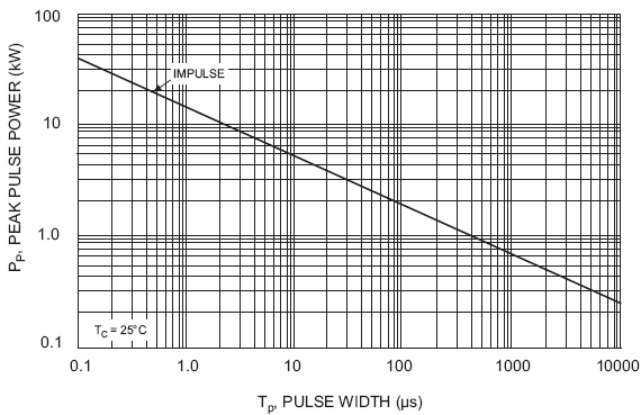
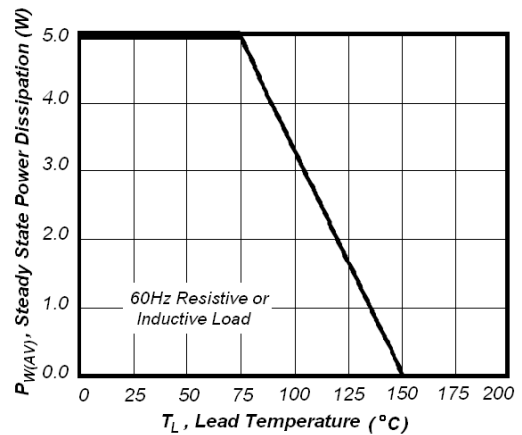
**Ratings and Characteristic Curves** ( $T_A = 25^\circ\text{C}$  unless otherwise noted)

**Fig1. Pulse Derting Curve**

**Fig2. Maximum Non-Repetitive Peak Forward Surge Current**

**Fig3. Pulse Waveform**

**Fig4. Typical Junction Capacitance**

**Fig5. Peak Pulse Power Rating curve**

**Fig6. Steady State Power Derating Curv**