

## Features

- ESD protection of high-speed data lines
- Low capacitance 0.15 pF : 1005(0402) size  
0.15 pF : 1608(0603) size
- Good ESD suppression characteristics
- Good ESD withstand ng
- RoHS compliant

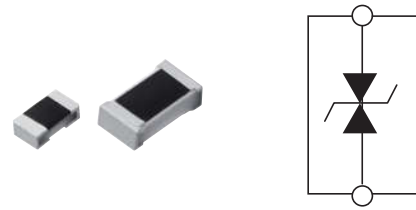

## Recommended Applications

- Smart phones, Mobile phones, RF Modules, NFC and GPS
- ESD suppression of high-speed differential data line such as Antenna circuit, HDMI, SATA, USB, Display Port

## Construction

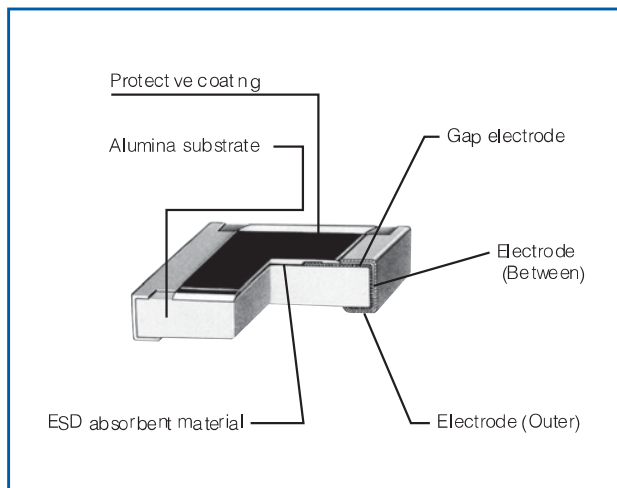

## Dimensions in mm (not to scale)

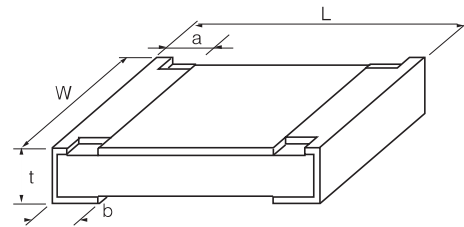

Part No. (inch size)	Dimensions (mm)					Mass (Weight) [g/1000 pcs.]
	L	W	a	b	t	
(0402)	1.00 <sup>+0.10</sup>	0.50 <sup>+0.05</sup>	0.20 <sup>+0.10</sup>	0.25 <sup>+0.10</sup>	0.38 <sup>+0.05</sup>	0.6
(0603)	1.60 <sup>+0.15</sup>	0.80 <sup>+0.15</sup>	0.30 <sup>+0.20</sup>	0.30 <sup>+0.20</sup>	0.50 <sup>+0.10</sup>	2.2

## Electrical parameters(T<sub>amb</sub>=25 °C)

Part Number	Working Voltage	Trigger Voltage	Clamping Voltage	Leakage Current	Capacitance
	V <sub>dc</sub>	V <sub>T</sub>	V <sub>C</sub>	I <sub>L</sub>	C <sub>P</sub>
	Max.	Typ.	Typ.	Typ.	Typ.
	V	V	V	nA	pF
PESD0402-050	5	150	35	1	0.15
PESD0402-140	14	150	45	1	0.15
PESD0402-240	24	150	50	1	0.15

- (1) Capacitance = The capacitance value shall be measured under the conditions specified below.  
Frequency : 1 MHz±10 %, Voltage : 1 V<sub>rms</sub>±0.2 V<sub>rms</sub> Temperature : 25 °C±2 °C
- (2) Peak Voltage = The peak voltage value shall be measured under the following conditions. ESD test conditions : IEC61000-4-2, 8 kV contact discharge
- (3) Clamping Voltage = The clamping voltage value shall be measured at 30 ns after initiation of pulse and measured under the conditions specified below.  
ESD test conditions : IEC61000-4-2, 8 kV contact discharge

## Frequency Characteristics

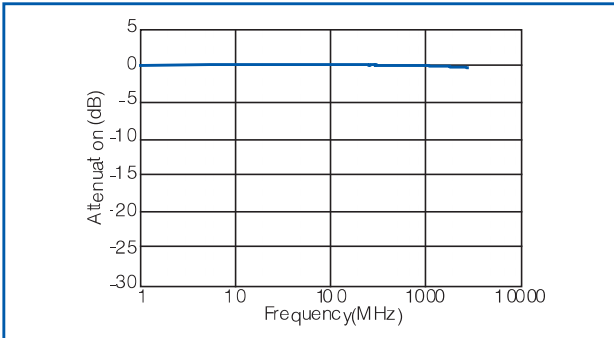

## ESD Suppression Voltage Waveform

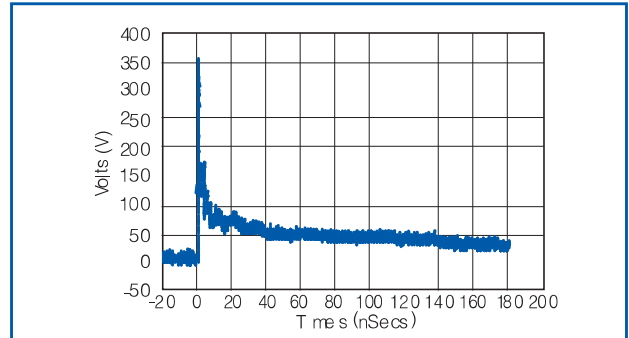

Operating & Storage Temperature Range:	-55°C to +110°C
ESD Capability: IEC61000-4-2 Contact Discharge IEC61000-4-2 Air Discharge	8kV typical 15kV typical
ESD Pulse Withstand*	>2000 typical

## Typical Circuits Requiring Protection

### ● HDMI circuit

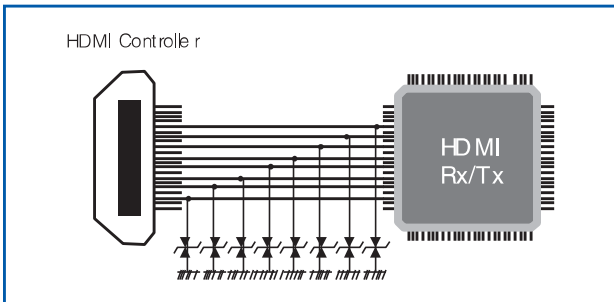

### ● Antenna circuit

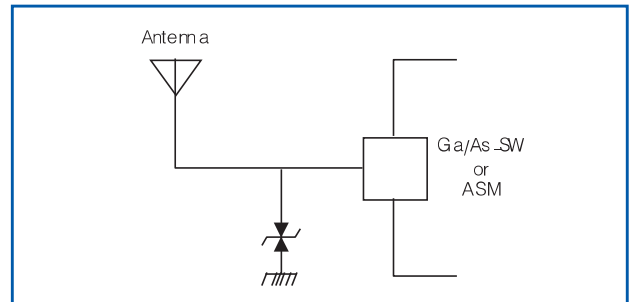

## Recommended Land Pattern

Recommended land pattern design for ESD Suppressor is shown below.

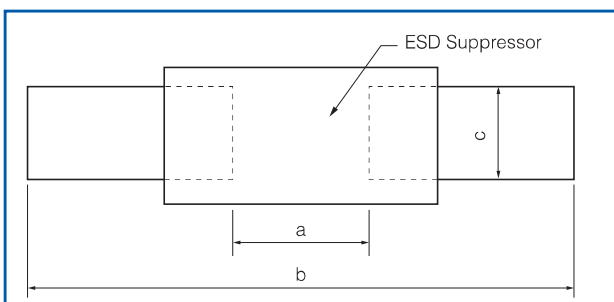

Part Number (inch size)	Dimensions (mm)		
	a	b	c
(0402)	0.5 to 0.6	1.4 to 1.6	0.4 to 0.6
(0603)	0.7 to 0.9	2.0 to 2.2	0.8 to 1.0